

# ELECTRIC STIMULATION AND THE EXCITATORY PROCESS IN THE NERVE FIBER

ICHIJI TASAKI

*From the Physiological Institute, Keio University, Yotsuya, Tokyo*

Received for publication October 20, 1938

In various experiments on the single nerve fiber, we find that an isolated nerve fiber behaves in a grossly different manner from an ordinary nerve trunk in many respects. Sometimes we received the impression that we were dealing with an entirely new excitable tissue that had never been studied before. Especially in studying the action of narcotics, the distinction between the nerve fiber and the nerve trunk is striking. When a narcotizing solution of an appreciable concentration is applied to these tissues, the nerve fiber loses its conductivity almost instantaneously at the moment of application (Tasaki, 1936), while the nerve trunk continues to conduct an impulse for many minutes. Further, narcotics affect the conductivity, in the nerve fiber, only at the nodes of Ranvier (Tasaki, 1936 and 1938).

Kubo and Ono's experiment (1934), which revealed remarkable variation in the threshold strength along the nerve fiber, has led me, through mathematical computations, to the conclusion that the myelin sheath must be an electric insulator which covers the axis-cylinder perfectly except at the nodes (1934). This conclusion is quite consistent with the results obtained by Erlanger and Blair (1934).

The present investigation was first designed to substantiate, by applying the method of multipolar stimulation (Rushton, 1928) to the isolated single nerve fiber, my previous conclusion that the nerve impulse was set up only at the nodes of Ranvier. The range of observation was then extended to include the problems of the strength-duration relation and of the excitatory process in the nerve fiber. Though I have succeeded in confirming my previous conclusion, the results obtained in this investigation were again very different from what might be expected from our previous knowledge of the nerve trunk. Further, it appears that the strength-duration relation, and with it the chronaxie, varies with the distribution of potential along the nerve fiber. The phenomenon first observed by Davis (1923) that the chronaxie varies with the size of the electrode is explained by new experimental data.

**METHODS.** In all experiments, the motor nerve fibers of the Japanese

toad were used. The procedure of isolation of single nerve fibers and the details of the treatment of the preparation prior to the experimentation are essentially similar to those described in a former paper (Tasaki, 1939). Fibers with long (over 2 mm.) and approximately constant internodal distances were selected. The preparation was mounted in the pools of Ringer's solution on a glass-plate with two sets of "ridge-insulators" (fig. 1, A and B). A node of Ranvier was introduced in the middle pool between A and B and was kept in the fluid. The width of the middle pool was 1.0 mm. and the length of the desiccated regions of the nerve

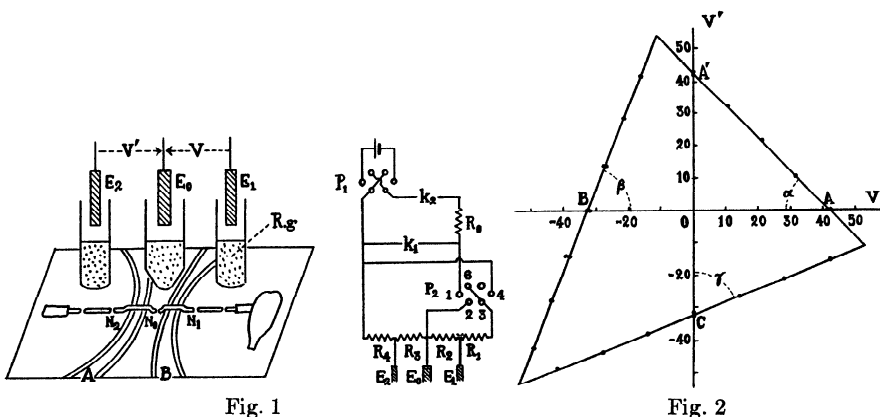

Fig. 1. Tripolar arrangement used for stimulation of an isolated single nerve fiber. *E*'s: electrodes. *N*'s: nodes of Ranvier. *P*'s: Pohl's reversers. *k*'s: contacts of Helmholtz pendulum. *R*'s: resistances. *R.g.*: Ringer-gelatin. *A* or *B*: ridge-insulator made with pieces of glass capillary coated with melted paraffin. The medullated regions of the nerve fiber which lie on the ridge-insulators *A* and *B* are desiccated in the air. The remaining parts of the nerve fiber are kept in Ringer's fluid.

Fig. 2. A "triangle" obtained by tripolar stimulation of a single nerve fiber. Arrangement shown in figure 1 is used. Duration of current pulses, 5 msec. Toad's sciatic-gastrocnemius preparation. Internodal distance, both 2.20 mm. Temperature, 9.3°C. Pause between stimuli, 15 seconds. Thresholds are expressed in millivolts.

fiber was 0.8-1.0 mm. In each of these three pools of Ringer which are insulated electrically from each other, non-polarizable electrodes (Zn-ZnSO<sub>4</sub>-Ringer or Ag-AgCl-Ringer) were dipped.

The arrangement of the exciting circuit is also shown in figure 1. The object of this arrangement is to produce any required potential drops, positive or negative, between electrodes *E*<sub>1</sub> and *E*<sub>0</sub> and between *E*<sub>2</sub> and *E*<sub>0</sub>, independently. The resistance *R*<sub>0</sub> was made constant and was 1,000 ohms throughout; *R*<sub>1</sub>, *R*<sub>2</sub>, *R*<sub>3</sub> and *R*<sub>4</sub> were so changed that they always satisfied the relation

$$R_1 + R_2 = R_3 + R_4 = R_0 = 1,000 \text{ ohms.}$$

If, in Pohl's reverser  $P_2$ , connections are made between 1 and 2 and between 3 and 4, the potential differences  $V$  and  $V'$  are given by

$$V = \pm eR_2/3,000 \text{ and } V' = \pm eR_3/3,000,$$

where  $e$  is the electromotive force of the accumulator (about 2.1 volts) and the symbol  $\pm$  indicates the direction of the drop of potential determined by the first reverser  $P_1$  (taking the directions marked by the arrows in the figure as being positive). If, on the contrary, 1 and 6 of the reverser  $P_2$  are connected together,

$$V = \mp eR_2/3,000 \text{ and } V' = \pm eR_3/3,000;$$

that is, the direction of  $V$  is reversed. Thus, by the use of these two reversers any combination of  $V$  and  $V'$ , positive or negative, can be obtained.

The contacts  $k_1$  and  $k_2$  are operated by a Helmholtz pendulum (Edelmann); with  $k_2$  closed, the opening of  $k_1$  initiates the current pulse, and the subsequent opening of  $k_2$  ends the pulse.

As the resistance across the ridge-insulator (A and B) is always enormously great, each pool of Ringer's solution can be treated as being equipotential. This is clear also from the experimental fact that the threshold strength is independent of the position at which the electrode  $E_0$  is dipped in the middle pool. The values of  $V$  and  $V'$ , therefore, as emphatically stated in a former paper, are equal to the potential differences between the pools. There is no appreciable polarization at the electrodes, as the currents through the electrode circuits are always extremely weak.

Determinations were made by giving a series of arbitrary potential differences across one set of the ridge-insulators, and by finding for each of these what potential difference had to be given across the other set of the ridge-insulators to obtain a threshold contraction. It will be noticed that the arrangements and the procedure are quite similar to those of Rushton's quadripolar stimulation (1928) except for the smallness of the material.

**RESULTS.** Figure 2 shows a typical set of experimental data obtained with current pulses of a duration of 5 msec. In this figure the potential difference  $V'$  across the central set of the ridge-insulators is plotted as ordinate against the potential difference  $V$  across the distal set of the ridges as abscissa. The strengths are adjusted to constitute threshold stimuli. The experiment is very simple to perform and the results are consistently repeatable.

It is clear that the results lie on three straight lines which constitute a "triangle." This triangle is apparently comparable to that obtained by Rushton (1928) with his tripolar electrodes on a nerve trunk, except that the angles  $\beta$  and  $\gamma$  are far less than right angles.

I. *The straight line in the first quadrant and the strength-duration relation.* The straight line in the first quadrant is always almost symmetrical with respect to both axes, that is, the angle  $\alpha$  is approximately equal to  $45^\circ$ . The greatest deviations observed are  $43^\circ$  (fig. 3) and  $48^\circ$ . As will be discussed in detail later, this line in the first quadrant corresponds to excitation at the node  $N_0$  in the middle pool.

As the duration of the current is reduced, the voltage necessary to excite naturally increases. But it should be noted that the angle ( $\alpha$ ) which the straight line makes with the abscissa is scarcely altered by changing the pulse duration in one and the same preparation. Figure 3 shows a

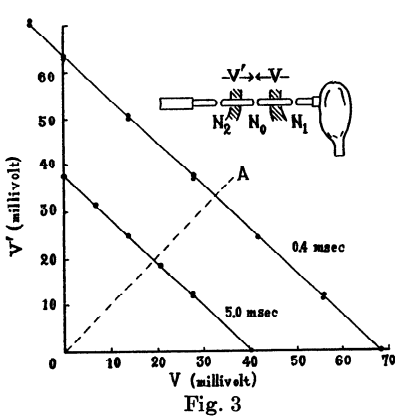

Fig. 3

Fig. 3. Straight lines in the first quadrant. Toad's sciatic-gastrocnemius preparation. Internodal distances, 2.04 mm. (between  $N_2$  and  $N_0$ ) and 2.19 mm. (between  $N_0$  and  $N_1$ ). Temperature,  $12.8^\circ\text{C}$ .

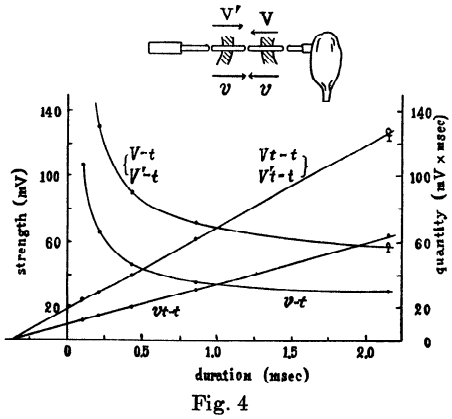

Fig. 4

Fig. 4. Comparison of the strength-duration curve obtained by tripolar stimulation ( $v-t$ ) with those obtained by usual bipolar stimulation ( $V-t$  or  $V'-t$ ). Toad's sciatic-gastrocnemius. Internodal distances: central, 2.65 mm.; distal, 2.98 mm. Temperature,  $11.2^\circ\text{C}$ . The point at which the  $Vt-t$  line crosses the abscissa represents the theoretical chronaxie, i.e., the ratio  $a/b$  in Weiss's formula.

result in which the durations of the current pulses employed were 5.0 and 0.4 msec. respectively. The two lines are parallel, the angle which they make with the abscissa being  $43^\circ$ .

The constancy of the slope of these lines immediately attests to the equality of the time-constants of the strength-duration curves measured with ascending current  $V$  and with descending current  $V'$ . The observed points on the horizontal axis (fig. 3) represent the liminal voltages necessary to excite the fiber with ascending current pulses of corresponding durations. If the strength-duration curve obtained with such ascending current pulses be denoted by  $V = f(t)$ , the curve obtained with descending current pulses  $V'$  must be given by  $V' = A f(t)$ , where  $A$  is a constant rep-

resenting  $\tan \alpha$ . In other words, the rheobase of the  $V'$ - $t$  relation may differ slightly from that of the  $V$ - $t$  relation but the chronaxie is always the same.

It follows from simple geometrical considerations that the same can be said of the strength-duration relation which can be obtained when the nerve fiber is stimulated with a combination of both ascending and descending currents ( $V$  and  $V'$ ) applied concurrently at a given constant ratio. Suppose, for example, that the middle pool of Ringer is connected to the cathode and both the central and the distal pools to the common anode (fig. 6, A), and that the strength-duration relation is determined with such arrangements. Then the potential difference  $V$  is always equal to  $V'$ , i.e.  $V:V' = 1$ ; this corresponds to determination of the points at which the straight line OA (which bisects the right angle at the origin) in figure 3 intersects the parallel straight lines relating  $V$  and  $V'$ . If, therefore, the strength-duration relation for  $V$  (when  $V' = 0$ ) is denoted by  $V = f(t)$  as before, the relation measured with these tripolar arrangements will be given by  $v = a f(t)$ , where  $a$  is a constant which, if  $\alpha = 45^\circ$ , equals  $\frac{1}{2}$ .

This is clearly shown in the experiment illustrated in figure 4, in which the relations  $V = f(t)$ ,  $V' = A f(t)$  and  $v = a f(t)$  were determined directly on the same preparation. The arrangement shown in figure 1 was used. At varying durations between 0.1 and 2.1 msec., the values of  $V$  necessary to excite when  $V' = 0$ , the values of  $V'$  when  $V = 0$  and the values of  $v = V = V'$  were determined in this sequence. In this example the voltage  $V$  (when  $V' = 0$ ) was equal to the corresponding value of  $V'$ , that is, the angle  $\alpha$  was  $45^\circ$ . The observed strength-duration relations were of the usual hyperbolic form and could roughly be expressed by the following formulae respectively:

$$V = 50 (3.4/t + 1),$$

$$V' = 50 (3.4/t + 1) \quad \text{and}$$

$$v = 25 (3.4/t + 1).$$

The rheobase (theoretical) of the  $v$ - $t$  relation was just one-half of that of the  $V$ - $t$  or  $V'$ - $t$  relation, but the chronaxies (theoretical) were all the same. This is exactly what was expected from the above-stated consideration of parallelism of the straight lines in the first quadrant.

These experimental results seemed at first to indicate that every spot (every node of Ranvier) on the nerve fiber has its own natural chronaxie which is independent of the method of its determination (i.e., Lapique's protoplasmic chronaxie, 1935). But the following investigations rendered this view untenable.

II. *The straight lines in the second and third quadrants and the strength-*

*duration relation.* In the second quadrant the direction of the potential drops  $V$  and  $V'$  are both descending; in the third quadrant  $V$  is descending and  $V'$  is ascending. Figure 5 gives the results of determinations made with current pulses of varying durations. Considering the wide range of the observations, all the results are seen to lie upon straight lines with great accuracy. As will be discussed later, these lines correspond to excitation at the node  $N_1$  in the figure. The broken lines near the vertical axis are of course continuations of the lines in the first quadrant which correspond to excitation at the middle node  $N_0$ .

The most remarkable point in this experiment is the non-parallelism between these straight lines for different durations. As the duration is reduced, the angle  $\beta$  which the straight line makes with the abscissa be-

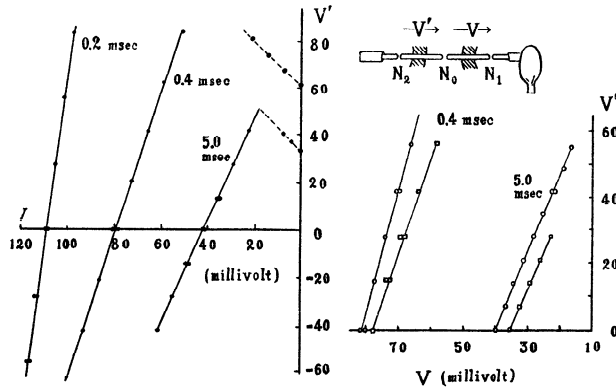

Fig. 5. Straight lines in the second and third quadrants. Left: sciatic-gastrocnemius; internodal distances,  $N_1 - N_0 = 2.98$  mm.,  $N_0 - N_2 = 2.26$  mm.; temperature,  $12.8^\circ\text{C}$ . Right, circles: sciatic-sartorius;  $N_1 - N_0 = 2.48$  mm.,  $N_0 - N_2 = 3.45$  mm.;  $9.8^\circ\text{C}$ . Right, squares: sciatic-gastrocnemius;  $N_1 - N_0 = 2.20$  mm.,  $N_0 - N_2 = 2.30$  mm.

comes greater. With current pulses of a duration of 5 msec.,  $\cot \beta$  is in most cases between 0.45 and 0.35, and, as the duration is reduced infinitely (other experiments),  $\cot \beta$  approaches a value between 0.25 and 0.15.

We shall again consider the strength-duration relation which can be obtained when potential differences  $V$  and  $V'$  are applied concurrently at a constant ratio (e.g., by using the arrangement shown in fig. 6, B). This means the determination of the points at which a straight line which passes through the origin (OA or OA' in fig. 7) intersects the lines relating  $V$  and  $V'$  at different durations.

In the diagram shown in figure 7, suppose that the two straight lines represent the relations between the potential differences  $V$  and  $V'$  when

the pulse durations are  $t$  and infinity respectively, and that the line OA in the figure represents the ratio  $V:V'$  at which these two current pulses are superimposed. Then it can easily be shown that the chronaxie which can be obtained with the descending current  $V$  (when  $V' = 0$ ) is shorter than that which may be obtained with this type of superimposed current pulses.

The voltage  $V_0$  in the figure represents the rheobasic voltage measured with the simple descending current pulses, as it is nothing but the liminal voltage for infinite duration. Similarly, the rheobasic voltage measured with the superimposed current pulses is given by  $(v_0 + v_0')$  which is directly proportional to  $v_0$  (cf. fig. 6, B). If we take  $V$  as being equal to  $2V_0$ , the pulse duration  $t$  represents the chronaxie which can be obtained with the simple descending current pulses. Since  $\beta$  in the figure is by experiment larger than  $\beta_0$ ,  $v$  must be larger than  $2v_0$ . Thus  $(v + v')$  is larger

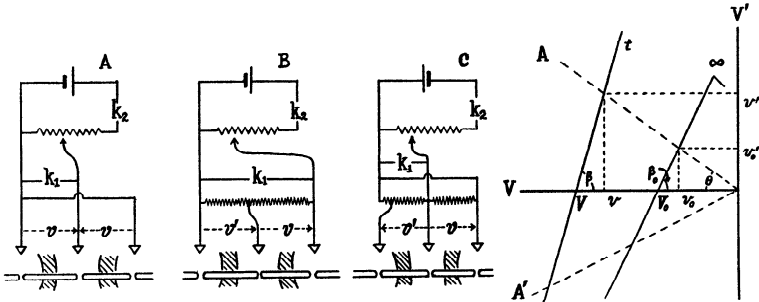

Fig. 6

Fig. 6. See text

Fig. 7

Fig. 7. See text

than  $2(v_0 + v_0')$ , namely, more than twice the rheobase measured with the superimposed current pulses. In other words,  $t$ , the chronaxie measured with the simple descending current pulses, is shorter than the chronaxie which can be obtained with this type of superimposed current pulses. Thus it is clear that the chronaxie observed is longer when a nerve fiber is excited with the superimposed current pulses ( $V + V'$ ) than when it is excited with potential differences localized between two neighboring nodes of Ranvier.

Figure 8 gives the results of an experiment in which two strength-duration relations were alternately determined on one and the same preparation, one measured with potential differences  $V$  (when  $V' = 0$ ) and the other determined with superimposed current pulses  $v$  when  $V':V = 1$ . The value of the rheobase and the chronaxie were, for the former relation, 38 millivolts and 0.51 msec. and, for the latter, approximately 27.5 millivolts and 0.58 msec. respectively. The difference in the chronaxie was

about 10 per cent, but it is clear that this could be made much greater by increasing the ratio  $V':V$ .

If, on the contrary, the direction of the potential drop  $V'$  is reversed (e.g., by using the arrangement shown in fig. 6, C) so that the straight line representing the ratio  $V':V$  lies in the third quadrant (as  $OA'$  in fig. 7), the chronaxie is shortened and the rheobase is raised. The degree of change in the chronaxie depends of course upon the ratio at which  $V$  and  $V'$  are applied concurrently. The greater the ratio  $V':V$ , the longer is the chronaxie. It can vary continuously in either direction, smaller or larger, according to the sign of the potential drop  $V'$ .

An analytical consideration of the problem will make this point still clearer. Let the ratio  $V':V$  be  $r = \tan \theta$ , where  $\theta$  is a constant which can vary according to the experimental condition from about  $68^\circ$  (or still

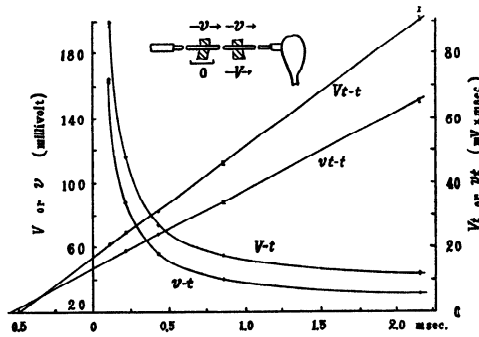

Fig. 8. Comparison of the strength-duration curve obtained by tripolar stimulation ( $v-t$ ) with that obtained by bipolar stimulation ( $V-t$ ). Deviation of the  $v-t$  relation from Weiss's law is only slight in this experiment. Sciatic-gastrocnemius preparation. Internodal distances: central, 2.12 mm.; distal, 2.67 mm.  $11.0^\circ\text{C}$ .

more on some particular occasions) to  $-45^\circ$  (see fig. 7). Then, for any duration of current,

$$v \tan \theta = (V - v) \tan \beta.$$

Hence

$$v = \frac{\tan \beta}{\tan \beta + \tan \theta} V.$$

Here, let the function  $B(t)$  represent  $\cot \beta$ , and let  $V = f(a, b, c, \dots, t)$  represent the strength-duration curve measured with the simple descending current pulses  $V$ , where  $a, b, c, \dots$  are the constants which characterize the curve. Then we have

$$v = \frac{1}{1 + rB(t)} f(a, b, c, \dots, t).$$



Denoting the right-hand side of this equation simply by  $F(t)$ ,  $v = F(t)$  expresses the strength-duration measured with the superimposed current pulses. As we have seen already,  $B(t)$  is a continuous function of the duration  $t$ , and varies with  $t$  from about 0.2 up to about 0.45; and  $r$ , the ratio, is an arbitrary constant which can vary in this experimental condition from about +2.5 to -1.0.

It is of interest that the strength-duration relation  $v = F(t)$  cannot be expressed by the same form of function as  $f$  (simply by changing its constants), namely, in the form  $f(a', b', c', \dots, t)$ . If  $V = f(a, b, c, \dots, t)$  is of hyperbolic form,  $v = F(t)$  is not in general a hyperbola when an arbitrary value is chosen for the ratio  $r$ . Under these experimental conditions, the formula  $v = F(t)$  represents the general strength-duration relation;  $V = f(a, b, c, \dots, t)$  is involved in it as being a special case in which  $r = 0$ . The value  $r$  indicates the manner in which the applied potential is distributed along the nerve fiber. *Thus it is evident that the strength-duration curve of a nerve fiber changes simply by changing the distribution of potential along the fiber.*

In the usual experiments with nerve trunks, it never happens that the applied potential drop is localized between two neighboring nodes as in the present experiments with "ridge-insulators." The stimulating current is distributed all along the stretch between and probably around the two electrodes. The strength-duration relation obtained under such circumstances must be much more complicated than those stated above in which the applied potential difference is localized between two or three neighboring nodes. It must involve many constants  $r, r', r'',$  etc., indicating the ratios of the potential differences between nodes of Ranvier, and, consequently, it will have very little meaning, as we know little or nothing about the distribution of potential at the nodes of the nerve fiber in each case.

Many attempts have been made in the past to formulate the law of electric excitation of the nerve, with the hope that all the experimental data may be covered ultimately by a single formula with several constants which characterize the irritability of the tissue. But now it is clear that no simple equation with two or three arbitrary constants can describe the complexity of electric excitation of the "nerve trunk."

III. *Plasma membrane and excitatory process at the nodes of Ranvier.* The original purpose of the present investigation was to examine the electrical properties of the myelin sheath and the significance of the node of Ranvier in the electric excitation of a nerve fiber. It can easily be deduced from the above-cited experimental results that the myelin sheath is a practically perfect electric insulator and consequently that the nodes are the only spots where the excitatory state is built up by an electric current.

In the experiment of figure 2, the observed points in the first quadrant lie on a single straight line AA' which is approximately symmetrical with respect to both axes, that is,

$$V + V' = \text{constant},$$

where  $V$  and  $V'$  are the potential differences across the central set and across the distal set of ridge-insulators directed towards the middle pool of Ringer's fluid. It follows directly from this relation that the effects of stimulation with  $V$  and  $V'$  (i.e., the excitatory states produced by  $V$  and  $V'$ ) are superposed at a single point on the nerve fiber between the two insulated regions. Since the nerve fiber is apparently continuous except at the node of Ranvier, the node  $N_0$  must be the very point where the excitatory states effective as regards excitation are built up by these potential differences. *It is obvious that an electric current excites the nerve fiber only at the node of Ranvier where the applied electromotive force produces an outward-directed potential drop across the plasma membrane.* This conclusion is directly supported by the experimental fact that if, in the arrangement shown in figure 6, A, no node is introduced in the middle pool, the rheobasic voltage can rise up to 1 volt or more.

Since Nernst's theory of nerve excitation, stress has been laid by many investigators upon the semipermeable membrane of the tissue where the ions effective as regards excitation accumulate. Now, there seems no doubt that the short cylindrical surface of the axis-cylinder, not covered by the myelin sheath, is the place where Nernst's polarization occurs. As is clearly shown in the diagram (fig. 9, A), this part of the plasma membrane is the only place where the currents  $i$  and  $i'$  flowing along the axis-cylinder can produce a summated effect.

Since the potential difference applied across the ridge-insulator can produce an excitatory state at the node, the myelin sheath cannot be a good electrical conductor. If it were an imperfect insulator, the current flowing along the axis-cylinder would diminish exponentially with increasing distance from the insulated region. Therefore, when the node  $N_0$  was situated not exactly in the middle of the pool but, say, nearer to the central set of the ridges (fig. 1, A), the potential difference  $V'$  should be more effective than  $V$ . Thus the angle  $\alpha$  in figure 2 should vary with the position of the node. But the actual experimental data show that  $V$  and  $V'$  are always equally effective and, in consequence, the angle  $\alpha$  is approximately equal to  $45^\circ$  ( $43^\circ$ - $48^\circ$ ). The myelin sheath must therefore be regarded as a *practically perfect insulator*.

We have seen that all the points on the straight line in the first quadrant, including the point A and A' in figure 2, represent excitation at the node  $N_0$ . Hence it is evident from symmetry that at the point B and C in figure 2 excitation occurs at the nodes  $N_1$  and  $N_2$  respectively. From

this it follows directly that the two straight lines passing through the points B and C in the figure represent excitation at these nodes on both sides of  $N_0$ . Let us consider why the straight line in the second and third quadrant shows, unlike Rushton's experiment on the nerve trunk, a slope far smaller than a right angle.

Since the outward-directed current through the node (or the potential drop across the membrane at the node) is proved to be effective as regards excitation, decrease in the threshold strength for  $V$  by superimposition of concurrent  $V'$  (fig. 5) indicates that not only  $V$  but also  $V'$  produces an outward-directed current at the node  $N_1$ . And this will occur when, and only when, the plasma membrane at the node exhibits enormously great electric resistance.

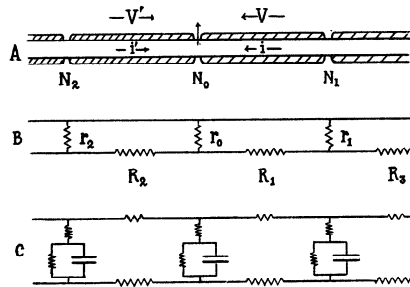

Fig. 9. Diagram representing the electrical circuit in the nerve fiber.  $R$ 's: resistance along the axis-cylinder between the nodes; it would probably be a homogeneous cylindrical strand of specific resistance of about 80 ohms (Ringer's fluid), about 7 microns in diameter and about 2.5 mm. in length.  $r$ 's: resistance due to polarization of the plasma membrane at the node. In diagram C, the  $r$ 's are replaced by leaky condensers and the resistance through the surrounding medium is shown by short zigzags.

Figure 9, B shows the diagram of the electrical circuits in the nerve fiber constituted from these considerations. The symbols  $R_1, R_2, R_3, \dots$  indicate the resistances of the internodal interval along the core; they would probably be purely ohmic resistances of the order of several tens of megohms. The symbols  $r_0, r_1, r_2, \dots$  represent the resistances through the plasma membrane at the nodes, due evidently to polarization by the current at this semipermeable membrane. The resistance through the surrounding medium is always very small as compared to  $R$  and  $r$ , and is omitted in the diagram. If the  $r$ 's in the figure were negligibly small as compared to those through the axis-cylinder ( $R_1, R_2, R_3, \dots$ ), it would be impossible for the potential difference  $V'$  applied between the node  $N_0$  and  $N_2$  to produce an excitatory state at the remote node  $N_1$ . The result shown in figure 5 can be explained only by assuming a great resistance (of the order of ten megohms) through each node of Ranvier.

Since this resistance across the node is considered to be a polarization resistance, its value will augment as the current passes through the membrane. Thus, the longer the duration of the current pulse, the more readily is the excitatory state built up at the remote nodes. This deduction is directly supported by the experimental fact that the angle  $\beta$  decreases with increasing pulse duration (fig. 5).

The term "excitatory state" (or excitatory disturbance) here is used to describe the state or condition, without any implication as to its physical nature, which, if it attains a certain constant level, releases an observable nerve impulse. The experimental results that have been described give us some perfectly rigid information as to the manner in which this state is built up at the plasma membrane at the node by the stimulating current.

In the experiment of figure 5, the excitatory state set up at the node  $N_1$  by the potential difference  $V$  can naturally be considered as a single-valued function of  $V$ , the voltage, and  $t$ , the time from the onset of the current pulse. The form of this function is unknown, and we shall denote it by  $E(V, t)$ . Similarly, the excitatory state built up at the same node  $N_1$  by the voltage  $V'$  applied between the nodes  $N_0$  and  $N_2$  may be denoted by  $E'(V', t)$ . The form of this latter function is of course quite different from that of the former, since  $E'(V', t)$  is concerned with the remote effect of the current while  $E(V, t)$  describes the process at the node where the current is applied directly.

If the potential differences  $V$  and  $V'$  are applied concurrently, the excitatory states  $E(V, t)$  and  $E'(V', t)$  are considered to produce a summated effect. In order that the relation between  $V$  and  $V'$  for threshold excitation shall lie on a straight line (fig. 5), the following two conditions have to be satisfied.

(1) The resultant excitatory state at the moment  $t$  is equal to the sum of  $E(V, t)$  and  $E'(V', t)$ .

(2) The values of  $E(V, t)$  and  $E'(V', t)$  are directly proportional to the voltage  $V$  and  $V'$  respectively; that is, if  $n$  and  $m$  are arbitrary (real) constants,  $E(nV, t) = nE(V, t)$  and  $E'(mV', t) = mE'(V', t)$ .

Thus, when a nerve fiber is just excited with potential differences  $V$  and  $V'$  of duration  $t_0$  applied concurrently, we have

$$E(V, t_0) + E'(V', t_0) = V E(1, t_0) + V' E'(1, t_0) = \text{constant},$$

where  $E(1, t_0)$  and  $E'(1, t_0)$  represent the values of the excitatory states at the moment  $t_0$  set up by a unit potential difference and are evidently constant for the given nerve fiber. The last equation describes the linear relation between  $V$  and  $V'$ . The excitatory state can be either positive or negative according to the direction of the potential difference, that is,

according to the sign of  $V$  or  $V'$ . The negative excitatory state follows exactly the same laws as the positive one.

The condition (1) above-cited may be called the *law of superposition*. It states that the excitatory state set up by  $V$  and  $V'$  applied concurrently is equal to the sum of those which will be produced when  $V$  and  $V'$  are applied separately. Close analogies are found in physical systems: e.g., the potentials produced by charges on a system of conductors or the current produced by electromotive forces in a net-work of resistances and condensers.

The condition (2) may be called the *law of proportionality*. This, however, cannot be regarded as independent of the former law; it can be involved in the former as being the limiting case in which  $V$  and  $V'$  are applied at the same region of the nerve fiber. Thus we may state these laws in the following form: When a nerve fiber is stimulated with potential differences  $V, V', \dots$  of duration  $t$  applied concurrently between different nodes of Ranvier, the excitatory state (e.s.) produced at a node is a linear function of  $V, V', \dots$ ; that is,

$$\text{e.s.} = E V + E' V' + \dots$$

where the coefficients  $E, E', \dots$  are the function of only the pulse duration  $t$ .

Since we have assumed that the threshold is reached when the excitatory state  $E(V, t) = V E(1, t)$  attains a critical positive value (say  $k$ ), the curve defined by the equation  $V = k/E(1, t)$  expresses the strength-duration relation measured with  $V$ , which by experiment is closely hyperbolic. Thus the shape of the function  $E(V, t)$  can be determined by the observation of the strength-duration relation.

It seems quite natural to consider that the excitatory state reaches the maximum immediately before the break of the applied current. If, however, its maximum is assumed to lag behind the break of the current (Bouckaert and Colle, 1937), it may be necessary to modify the above-stated definition of  $E(V, t)$  as the maximum value of the excitatory state produced by a potential difference  $V$  of duration  $t$ , the lag of the maximum being independent of the value of  $V$  or  $V'$ . We shall reserve the problem of the lag for a subsequent paper and shall confine our attention, in this paper, to the previous definition, neglecting such a lag.

Similarly the curve defined by  $V' = k/E'(1, t)$  represents the strength-duration relation for the remote effect, i.e., measured with the potential difference  $V'$  (fig. 5) when excitation at the node  $N_1$  is taken as index. But this cannot be observed directly as excitation occurs at the node  $N_0$  at lower voltage than at  $N_1$ . It can be obtained by extrapolating the straight lines in figure 5 and by determining the points at which these lines cross the vertical axis.

If, in the experimental arrangement shown in figure 5, Ringer's fluid in the middle pool is replaced with a dilute narcotizing solution, it sometimes happens that the broken lines (in fig. 5, left) shift upwards and the continuous lines directly cross the vertical axis, due apparently to rise of threshold at the node  $N_0$ . Under such conditions, the relation  $V' = k/E'(1, t)$  can be determined directly and it gives a chronaxie longer than the normal ("the abnormal prolongation of chronaxie by narcosis").

It is clear from the experiment of figure 5 that  $E'(1, t)$  rises more slowly than  $E(1, t)$  and approaches, as the time elapses, the maximum, which is 0.45–0.35 times as large as that of  $E(1, t)$ . The ratio  $E'(1, t)/E(1, t)$  gives the slope of the straight line in the second and third quadrants, being equal to the function  $B(t)$  introduced to describe the variation in the strength-duration curve with the change of the distribution of potential along the nerve fiber. Dependence of this ratio upon the time  $t$  is undoubtedly due to the variable polarization resistance through the plasma membrane.

In the experiment of figure 3, the excitatory state produced at the node  $N_0$  by the potential difference  $V$  is given by the function  $E(V, t)$  and that produced by  $V'$  at the same node is also given by the same function  $E(V', t)$ . Hence, by the law of proportionality and superposition, the relation between  $V$  and  $V'$  for threshold excitation is

$$VE(1, t_0) + V'E(1, t_0) = k,$$

where  $t_0$  is the duration of the current pulse. This equation describes the linear and symmetrical character of the straight lines in the first quadrant.

**DISCUSSION.** It is evident that the above-stated results obtained with nerve fibers account for the reduction of the chronaxie in the "nerve trunk" by a diminution of the size of the electrode (Davis, 1923; Lapique, 1931) or by decrease in the distance between electrodes (Rushton, 1927). When the size of the electrode is made small, as in Sakamoto's experiment (1933), the current density becomes very great around the electrode, and the potential difference would be localized roughly between two or three nodes near the electrode. Consequently the strength-duration curve obtained would approach those shown in figure 4. And much the same may be said of the case of very short interpolar distance.

When the size of the electrode applied to the nerve trunk is made greater, potential differences would appear between all the internodal intervals in the interpolar region. But at the region where the gradient of potential is constant, applied current produces no outward-directed potential drop through the node. The positive excitatory states are set up only at the nodes near the cathode. At threshold, a nerve fiber, of which a node happens to be situated at a point most favorable for stimulation, is excited by the sum of the excitatory states set up by potential

differences between the nodes at various distances from the node to be excited. Consequently, the chronaxie thus determined would give a value greater than those obtained in the experiment of figure 8.

Bishop (1928) and others raise the question of deformation of the stimulating current by the polarization of connective tissue which surrounds the nerve. But no attention had hitherto been given to the fact that the connective-tissue sheath produces another, more remarkable, effect upon the nerve fibers inside, namely, the reduction of the gradient of potential near the cathode. Grundfest (1932) found that the strength-duration curve of the individual nerve fiber in the retrolingual membrane varied with the distance of the electrode from the fiber. Kubo and Ono (1934) showed with isolated nerve fibers that the chronaxie measured with the electrode on the myelin sheath (at a point half-way between two nodes) is 2 to 4 times as large as that obtained with the electrode directly on a node. All these facts can be explained by the alteration of distribution of potential along the nerve fiber. The deformation of the stimulating current by the polarization at the connective tissue does not seem to bring about a greater change upon the strength-duration curve than does the reduction of the gradient of potential.

The diagrams of figure 9 showing the electrical circuits in the nerve fiber are of some importance. The figure gives very clear explanations from the physical point of view for some of the well-known phenomena. For example, the *spread of the stimulating current* can be regarded as a logical consequence of this electrical net-work.

When a localized potential difference is applied between two neighboring nodes (e.g., by the use of a ridge-insulator), the positive and negative excitatory state is set up all along the nerve fiber, its magnitude being dependent upon the remoteness from the site of application of the potential difference. At the node near the ridge-insulator, its value is greatest. At the adjoining node, it is, from what has been stated already,  $\cot \beta$  times as large; and at the  $n$ -th node it would probably be about  $(\cot \beta)^n$  times as large. (The calculation of this value is reserved for a subsequent paper.) If, therefore, the voltage of  $1/(\cot \beta)^n$  times the threshold voltage at that duration is adopted for stimulation, the propagated disturbance is expected to start at the  $n$ -th node from the cathode. This type of current spread can be checked by crushing the nerve fiber and would evidently be what was labeled "internal spreading" by Kato (1926). His "external spreading" probably means the spread of lines of flow in the conductive medium which surrounds the fibers in the nerve trunk.

The electric resistance through the surrounding medium would always be small as compared with the resistances along the axis-cylinder inside the myelin sheath. The action potential we measure seems to be a small fraction of the electromotive force developed at the excitable interface at the node of Ranvier.

## SUMMARY AND CONCLUSIONS

1. By the method of tripolar stimulation, the mechanism of electric excitation of the nerve fiber has been investigated.

2. The plasma membrane at the node of Ranvier (coaxial with the axis) is the place where Nernst's polarization occurs. The resistance through this membrane is inferred to be of the order of ten megohms as measured with the stimulating current.

3. The myelin sheath must be regarded as a practically perfect electric insulator.

4. The excitatory state (or disturbance) is produced by the outward-directed potential-drop across the plasma membrane at the node. The "law of proportionality and superposition" (p. 392) applies to this state.

5. When a potential difference is applied to a nerve fiber between two neighboring nodes of Ranvier, excitatory states are produced all along the fiber. Spread of the stimulating current in the nerve trunk is explained upon a physical structural basis.

6. The strength-duration curve varies with the distribution of potential along the nerve fiber. Variability of the resistance through the plasma membrane accounts for this fact. The dependence of the chronaxie upon the size of the electrode and its allied phenomena are explained from this standpoint.

It is my wish to express to Prof. G. Kato and Dr. R. Kawakami my appreciation of their continual encouragement and valuable advice. To Dr. H. Davis my thanks are due for his kindness in improving the English.

## REFERENCES

- BISHOP, G. H. *This Journal* **84**: 417, 1928.  
 BOUCKAERT, J. P. AND J. COLLE. *J. Physiol.* **90**: lxxv, 1937.  
 DAVIS, H. *J. Physiol.* **57**: lxxxii, 1923.  
 ERLANGER, J. AND E. A. BLAIR. *This Journal* **110**: 287, 1934.  
 GRUNDFEST, H. *J. Physiol.* **76**: 95, 1932.  
 KATO, G. The further studies on decrementless conduction, p. 69, 1926.  
 KUBO, M. AND S. ONO. *Proc. Japan. Physiol. Soc., Biophysics* **3**: no. 3, 1934.  
 LAPICQUE, L. *J. Physiol.* **73**: 219, 1931.  
 RUSHTON, W. A. H. *J. Physiol.* **63**: 357, 1927.  
     *J. Physiol.* **66**: 216, 1928.  
 SAKAMOTO, S. *Pflüger's Arch.* **231**: 489, 1933.  
 TASAKI, I. See G. KATO. The microphysiology of nerve, p. 74, 1934.  
     *Proc. Japan. Physiol. Soc., Biophysics* **4**: no. 4, 1936.  
     *Keio Igaku (Japanese)* **18**: 387, 1938.  
     *This Journal* **125**: 367, 1939.